

Install the Enphase Enpower

To install the Enphase Enpower™ Smart Switch and the Enphase Enpower Wall-Mount Bracket, read and follow all warnings and instructions in this guide and in the *Enphase Enpower Installation and Operation Manual* at enphase.com/support. Safety warnings are listed on the back of this guide. These instructions are not meant to be a complete explanation of how to design and install an energy storage system. All installations must comply with national and local electrical codes and standards. **Only qualified electricians shall install, troubleshoot, or replace the Enpower.**

The Enphase Ensemble System includes the Enphase Enpower™ Smart Switch with Microgrid Interconnection Device (MID) capability, which consolidates interconnection equipment into a single enclosure and streamlines grid-independent capabilities of PV and storage installations by providing a consistent, pre-wired solution for residential applications. Along with MID functions, it includes PV, storage, and generator (future) input circuits.

Four unique installation scenarios are shown:

Whole home backup with Enpower as service entrance and PV combiner connected to Enpower. This is the preferred configuration for back up of the entire main load panel. This configuration supports up to an 80A breaker for the PV circuit and an 80A breaker for battery storage.

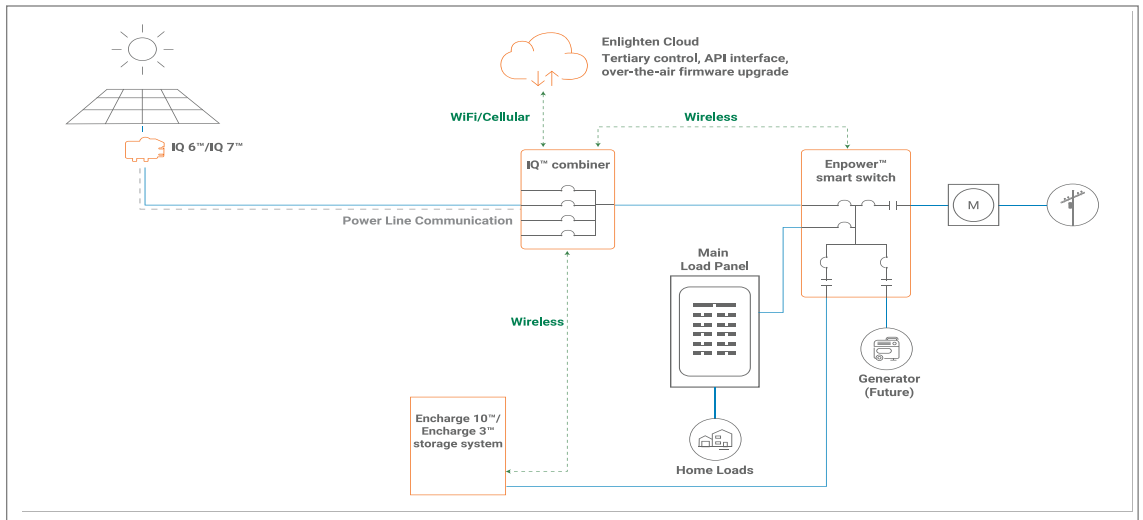

Whole home backup with Enpower as service entrance and PV combiner connected to main load panel. This is the preferred configuration when you back up the entire main load panel, and the size of the PV combiner circuit is more than 80A. In this configuration, the PV combiner circuit connection space in Enpower is left vacant. When existing PV combiner circuits are connected to the main load panel, and you want to add battery storage to the system, you can keep the PV combiner connected to the main load panel and connect only the battery storage system to Enpower.

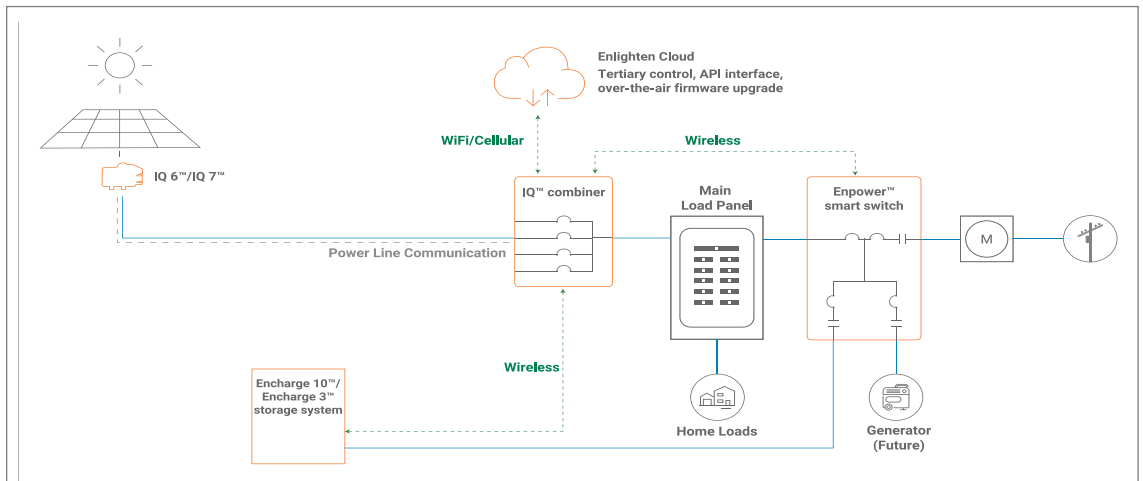

Partial home backup with main load panel as service entrance and PV combiner connected to Enpower. When PV circuits breaker size is less than 80A, this is the preferred configuration for partial home backup with sub-panel.

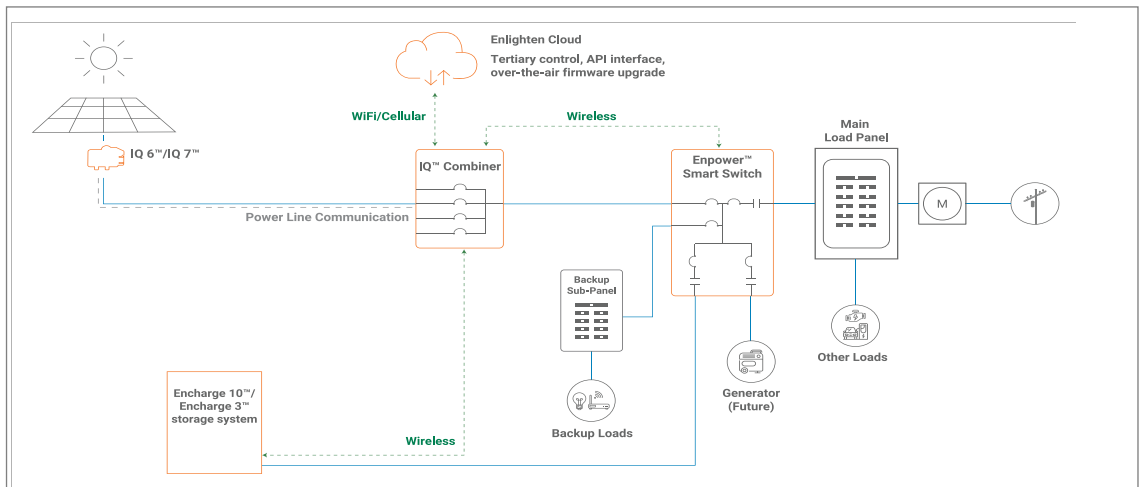

Partial home backup with main load panel as service entrance and PV combiner connected to sub-panel. This is the preferred connection configuration for partial home backup using a subpanel when the PV circuit breaker size is more than 80A. The space available in Enpower for combiner (solar) connection is left vacant.

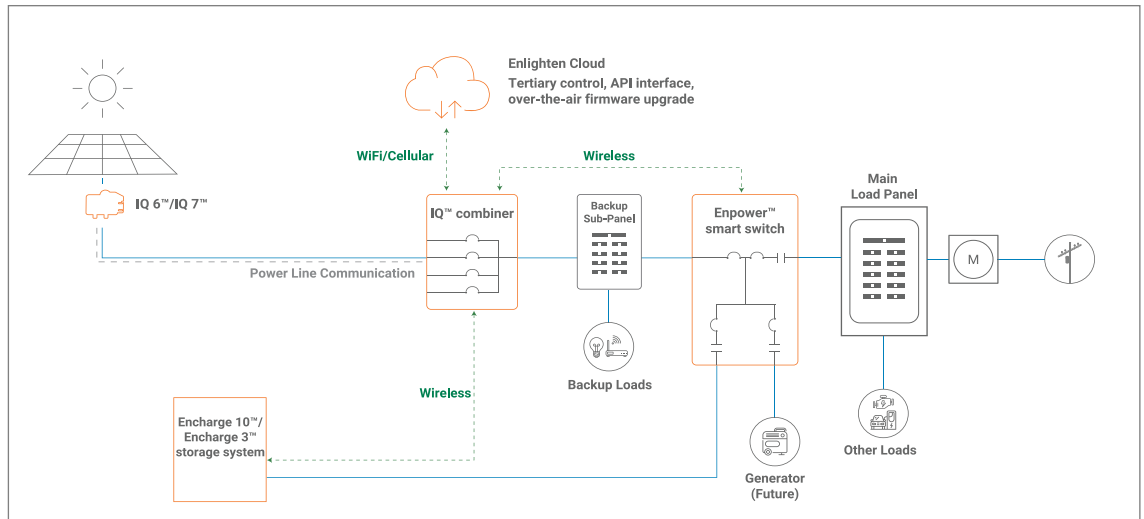

PREPARATION

- A) Inspect the packaging and the Enpower for damage. Do not install or use the Enpower if it has been damaged in any way.
- B) Ensure that you have the following:
 - One Enphase Enpower device. The Enpower shipping box contains an Enphase Enpower, mounting bracket, handles, and mounting hardware.
 - ⚠ **WARNING:** The Enpower device weighs 36 kg (80 lbs) and will require two persons to lift the unit.
 - An Enphase Enpower literature kit (150-00148)
- C) Make sure you have the following **required** items:
 - Enphase Encharge Battery(ies), which are required for off-grid applications.
 - The Enphase Enpower requires a wireless connection to an IQ Envoy, which requires an Internet connection. Failure to maintain an Internet connection may have an impact on the warranty. See enphase.com/warranty for full terms and services.
 - Wireless USB Adapter (COMMS-KIT-01) to be installed at Envoy for communications with Encharge and Enpower. Includes USB cable for connection to IQ Envoy / IQ Combiner and allows redundant wireless communication with Encharge and Enpower.
 - Eaton BR Series breakers, rated maximum 80A for Encharge Battery(ies) and Ensemble Combiner.
 - If breakers are required at the input or output to Enpower, use Eaton, Type CSR breakers rated 100 A, 125A, 150 A, 175A or 200 A.
 - Tools: conduit (with fittings and fitting tools), drill, 5/32 inch pilot bit (or metric equivalent), screwdriver, socket, wrench, adjustable wrench, torque wrench, level, 5/32 inch Allen key (or metric equivalent), conductor stripper, electrician's hole saw kit or punch set, and stud finder, if installing on studs.
 - Conduit fittings (hubs) are required for all installations, and NEMA Type 3 conduit fittings (hubs) are needed when installing out of doors (one for each used conduit opening).
 - Conduit ground hub rings.

NOTE: Conduit entry is allowed only through the bottom or bottom sides of the unit.

- Three #10 lag bolts or screws, 7.6cm (3 inches) long (depending on attachment wall), for each wall-mount bracket. Check with a structural engineer and local standards for local requirements.
- Washers for use between fastener heads and wall-mount bracket.
- Conductors rated at 75°C. **For sizes, refer to the table on the unit and to local codes.**
- Over current protection: maximum in accordance with local standards.

INSTALLATION

1 Plan a location for the Enpower

The Enpower housing is NEMA type 3R and can be installed indoors or outdoors.

- A) **Follow all local codes and standards when planning for and installing the Enphase Enpower Smart Switch.**
- B) Choose a well-ventilated location where the ambient temperature is within -40° C to 50° C (-40° F to 122° F), preferably out of direct sunlight.
- C) Ensure that the mounting location can sustain the weight of the Enpower and mounting bracket (36 kg / 80 lbs). The wall must include studs that can bear 36 kg (80 lbs) or can be of masonry or other suitable structure.
- D) Plan the mounting location:
 - Indoors: at least 30cm (one foot) off the ground and 30cm (one foot) from the ceiling.
 - Outdoors: at least 90cm (three feet) off the ground.
- E) Ensure that there are no pipes or electrical conductors where you plan to drill.
- F) Plan to maintain at least 90cm (three feet) of clearance in front of the Enpower.
- G) Consider the dimensions of the Enpower, easy access, unit height, conduit entry, and length of cable when selecting the location.
- H) Select a location where you can interconnect to the site's load center using the Enphase Enpower.

2 Install the wall-mount bracket

A) Mark a plumb line over the wall stud as a guide.

⚠ WARNING! Multiple risks. Make sure not to drill or attach into electric wiring or pipes that are in the wall!

B) Remove the wall mount bracket only from the shipping box.

C) Place the wall-mount bracket on the wall so that the mounting holes in the middle of the bracket align with the center of the stud. Use a level to keep the bottom of the wall-mount bracket level. Use the wood screws (or masonry attachments if installing in masonry) to attach the bracket using one screw and washer for each slot.

D) Verify that the wall-mount bracket is solidly attached to the wall.

⚠ WARNING! Risk of injury and equipment damage. Do not mount an Enpower on a bracket that is not properly attached to a wall.

⚠ WARNING! Risk of injury and equipment damage. Protect the Enpower from impact damage and improper use.

Enpower
Wall Mount Bracket

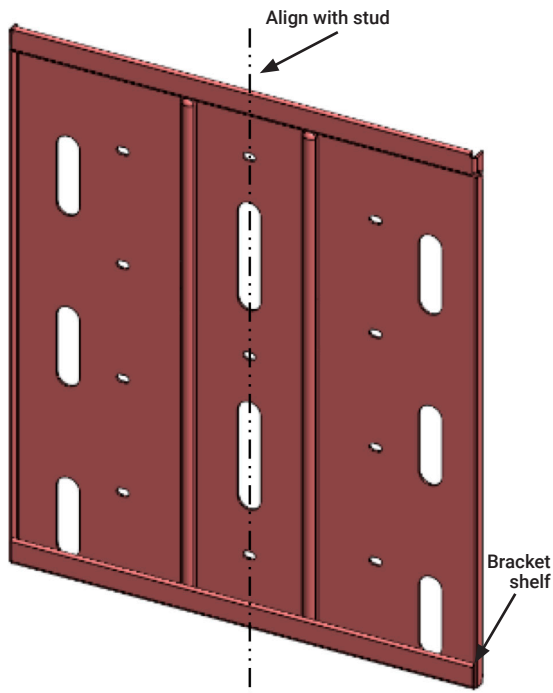

3 Unbox and Mount the Enpower on the wall

⚠ WARNING! Risk of injury. Take care when lifting. The Enpower is heavy (36 kg/80 lbs).

⚠ WARNING! Risk of injury and equipment damage. Avoid dropping the Enpower. Doing so may create a hazard, cause serious injury, and/or damage the equipment.

A) Locate the breakout feature on the side of the Enpower package.

B) Locate the shipping handles and M6 pan head screws and nuts.

C) Use the screws and nuts to fasten the lifting handles to both sides of the Enpower.

D) Use the lifting handles to take the Enpower from the packaging and place it right side up on a flat surface.

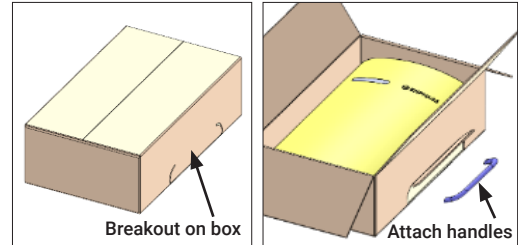

E) To record the location(s) of the Enpower device, peel the removable serial number label from the Enpower device and affix it to the respective location on a paper installation map. You will scan this map later using Enphase Installer Toolkit™ and your mobile device. You can find an example installation map at the back of any Enphase Microinverter manual. Or, you can create your own map.

F) Using the lifting handles and supporting the Enpower from underneath, lift the Enpower slightly above the installed wall mount bracket and allow it to slide down so that the bracket facing hooks set into both the top and bottom shelves of the wall mount bracket.

G) Allow the Enpower to slide down until the Enpower is fully seated on the wall-mount bracket shelf.

⚠ WARNING! Risk of injury and equipment damage. Do not release the Enpower until you ensure that the Enpower is fully seated in the wall-mount bracket shelf.

H) Use a screwdriver to reach into the recesses on the backsides of the handles to unscrew and remove the lift handles.

I) Reserve the handles, nuts, and screws in case you need to move the Enpower later.

J) On the bottom handle mounts, use the two provided partial-threaded custom M6 screws (**not the reserved screws**) and two of the reserved nuts on both side of the Enpower. The threaded portion of the screw engages with the bracket, while the unthreaded portion of the screw engages with the hole in the bracket to prevent vertical movement of the bracket

⚠ WARNING! Risk of injury and equipment damage. Do not skip this step. Without these screws in place, the Enpower may fall and cause injury or damage if bumped or shaken.

K) Use the two provided filler plates to cover the screws.

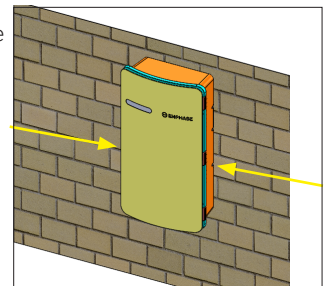
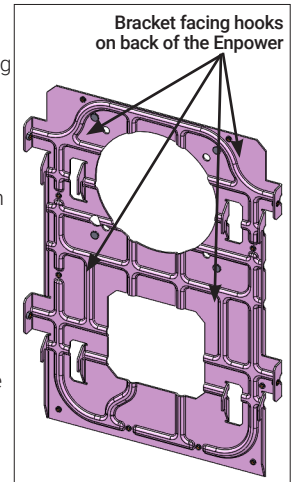

4 Install Breakers as Needed

The Enpower includes one two-pole 40A circuit breaker that feeds the neutral forming transformer (NFT). You can install additional breakers, if needed. You must follow all NEC and local electrical codes.

Install breakers as needed for the AC grid, main load, Enphase IQ Combiner, Enphase Encharge batteries, and generator (future). These breakers are not included and must be ordered separately.

NOTE: You must install a backup loads breaker if required by local code.

NOTE: Generator connection is not currently supported. This feature will be supported in future after an over-the-air software upgrade.

WARNING! Risk of injury and equipment damage. Use only the breakers listed in this table.

Allowed breaker types include:

Enphase Model No.	Type and Eaton part no.
BRK-100A-2P-240V	• Main Breaker, 2 pole, 100A, 25kAIC, CSR2100N
BRK-125A-2P-240V	• Main Breaker, 2 pole, 125A, 25kAIC, CSR2125N
BRK-150A-2P-240V	• Main Breaker, 2 pole, 150A, 25kAIC, CSR2150N
BRK-175A-2P-240V	• Main Breaker, 2 pole, 175A, 25kAIC, CSR2175N
BRK-200A-2P-240V	• Main Breaker, 2 pole, 200A, 25kAIC, CSR2200N
BRK-20A-2P-240V	• Circuit Breaker, 2 pole, 20A, 10kAIC, BR220
BRK-30A-2P-240V	• Circuit Breaker, 2 pole, 30A, 10kAIC, BR230
BRK-40A-2P-240V	• Circuit Breaker, 2 pole, 40A, 10kAIC, BR240
BRK-60A-2P-240V	• Circuit Breaker, 2 pole, 60A, 10kAIC, BR260
BRK-80A-2P-240V	• Circuit Breaker, 2 pole, 80A, 10kAIC, BR280

Breaker installation positions are noted in the diagram:

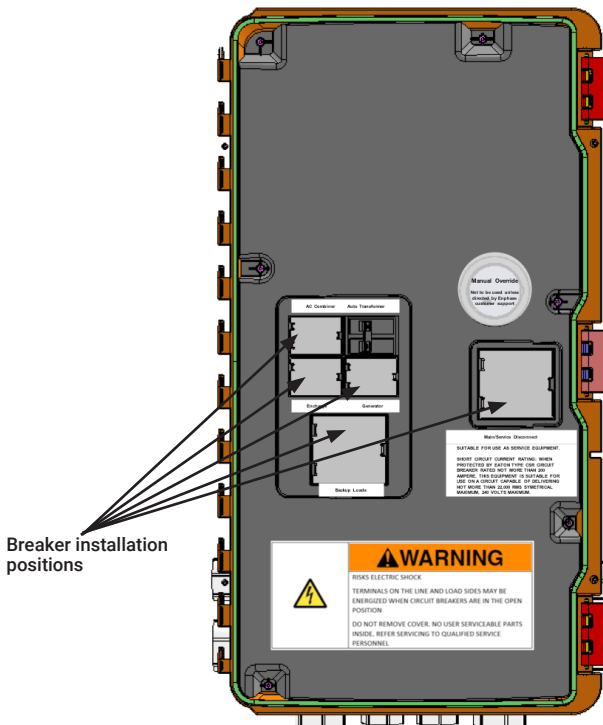

Breaker installation positions

Required practices when torquing connections:

- Always follow NEC 2017 110.4 (D) dictates.
- You must use a calibrated torque tool to achieve the indicated torque values.
- Use tamper-proof torque mark/paint after torquing connections.

- Ensure that the Enpower is completely de-energized.
- Open the three latches that lock the enclosure door. To release the latch, pull the latch handle forward and then to the right. With all the latches opened, swing open the enclosure door.
You can remove the door from the hinges if needed: Pinch the top of the hinge rod using a pair of needle-nosed pliers. Slide the door up and away to remove it. Set the door aside for later reattachment.
WARNING: Risk of equipment damage. Do not remove the pre-installed solar shield attached to the enclosure door.
- Use a Phillips screw driver to loosen the six screws along the periphery of the deadfront. Use the two tabs on the front to assist handling the deadfront during the removal. Keep the deadfront and screws handy as you will need them later.
WARNING: Risk of electric shock. To maintain the warranty, do not modify the deadfront other than to remove or replace filler plates, as needed.
- If you install a main breaker or load breaker, remove the standard lugs before installing the Eaton CSR breaker. By default, lugs are provided in the Enpower unit for connection to the mains and to the load. In case of usage without breakers, the conductors are connected directly to these lugs. When breakers are used, the lugs are replaced with breakers during installation.

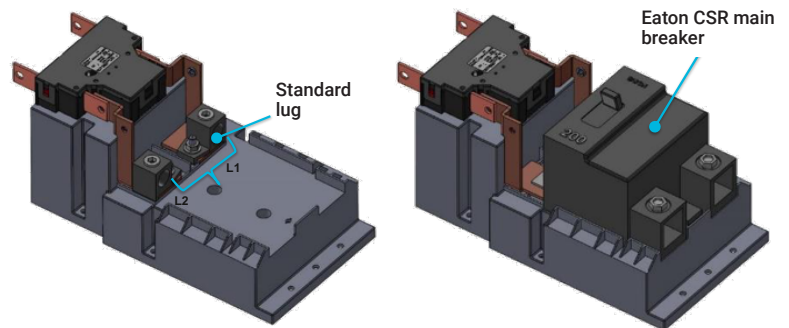

Lugs at main load breaker position

Breaker installed at main load position

- Remove a filler plate from the deadfront for each breaker position you will use. Refer to the breaker position diagram to the left. To remove the filler plate, press the single latch inward while gently pushing the filler plate out.
- For the Encharge, AC Combiner or Generator (future) connection, snap the appropriately sized BR series two-pole Eaton breaker onto the busbar, using only the breaker positions indicated in the diagram on the door of the unit. Breaker functional position are not interchangeable with one another. The wires to be connected to each breaker are located beside each breaker position. Remove the plastic cap on the wire ends before inserting into the breaker.
- Install each breaker by rocking it to the left, catching the clips that hold it in place. Then rock the breaker to the right so it is fully seated and secure.
- For the main load breaker, use an appropriately sized CSR Eaton breaker. Install at the location indicated in the diagram on the door of the unit.
- Remove the mains/load lugs by unscrewing the two nuts holding the lugs. Re-use the same nuts to fix the CSR breakers in the same position. Use the screw provided in the kit to secure the breaker.
- Torque the breaker connections as listed in the following and **in the conductor table on the unit.**

Connections	Wire size (AWG)	Torque (N·m / lb·in)
Main lugs	Cu/AL: 300 KCMIL - 2	31.1 / 275
Backup load lugs	Cu/AL: 300 KCMIL - 2	28.2 / 250
CSR breakers	6	3.1 / 27
BR breakers (wire provided)	14 - 10	2.8 / 25
AC Combiner lugs	8	3.4 / 30
Encharge lugs	4 - 6	3.9 / 35
Generator (future) lugs	2 - 3	4.5 / 40
Neutral - large lugs	Cu/AL: 300 KCMIL - 6	31.1 / 275
Neutral and ground bars		
Large holes	1/0 - 3	5.6 / 50
	4 - 6	5.1 / 45
	8	4.5 / 40
	10 - 14	4.0 / 35
Small holes	4 - 6	4.0 / 35
	8	2.8 / 25
	10 - 14	2.3 / 20

5 Wire the Field Connections

- A) Drill conduit entry holes as needed, and install conduit grounding lugs for each opening. Be sure to reseat unused conduit entry holes with sealing plugs.
- NOTE:** Main supply conductors may enter the Enpower from the bottom or from the bottom-left side. Backup load conductors may enter the Enpower from the bottom or bottom-right side. Encharge, Combiner and generator (future) conductors may enter from the bottom, bottom-left or bottom-right sides.
- B) Size the conductors (Line, Neutral and Ground) depending on the breaker or fuse, proper ampacity, and voltage rise requirements according to local codes. Refer to the conductor rating table on the door of the Enpower.
- ⚠ DANGER!** Risk of electric shock. Check that all circuits connecting to the Enpower are de-energized before wiring.
- C) If the Enpower is not installed at service equipment, you must remove the main bonding jumper connected between the grounding bar and the neutral assembly. Refer to the wiring diagram.
- NOTE:** Do not modify or rewire any of the other pre-installed wiring or bonding connections in the Enpower.
- D) If Enpower is installed as service equipment:
- Connect a grounding electrode conductor to the grounding bar.
 - From the literature kit, place the label "GROUNDING ELECTRODE TERMINAL" adjacent to the grounding bar.
 - From the literature kit, place the label "SUITABLE FOR USE AS SERVICE EQUIPMENT" on the deadfront near the main breaker/service disconnect.
 - From the literature kit, place the label "MAIN/SERVICE DISCONNECT" on the deadfront near the main breaker/service disconnect.
 - If Enpower is not used as service equipment, these labels should not be used.
- E) Connect Lines, Neutral, and Ground. **For details, refer to the conductor table on the unit for sizes and refer to local codes.**
- ⚠ WARNING!** Risk of equipment damage. Always connect to two Lines (active), one neutral, and one ground.
- F) Use the included stowed conductors, as labeled, to wire the circuit breaker(s) for the Encharge batteries, Enphase Combiner, and generator (future), as needed. The stowed conductors are provided with crimped-on ferrules with end caps to prevent accidental contact. Remove the conductor end caps as needed.
- G) Torque the breaker connections as listed on the previous page and **in the conductor table on the unit.**
- H) After all conductors are connected and secured, check that there are no exposed conductors or stray wires.
- I) Gently arrange all the conductors and connectors inside the cabinet.
- ⚠ DANGER!** Risk of electric shock. The system is not ready to be energized! Do not close any circuit breaker yet.

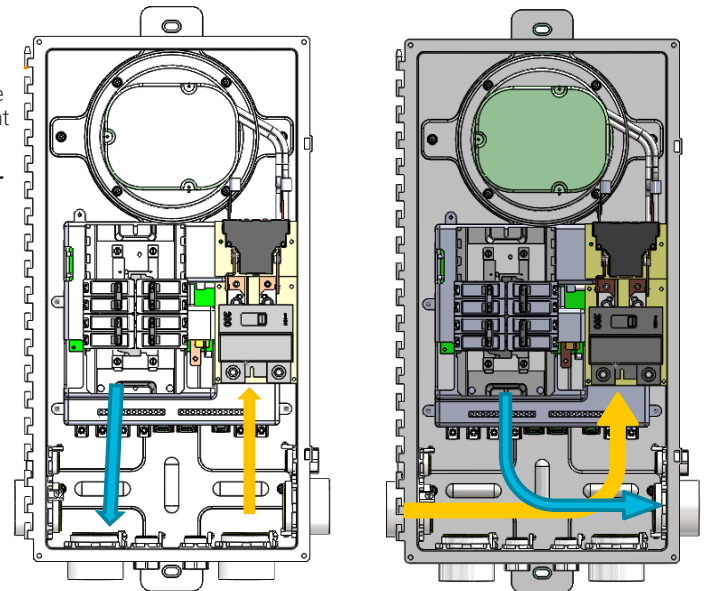

Conduit guidance - bottom entry

Conduit guidance - side entry

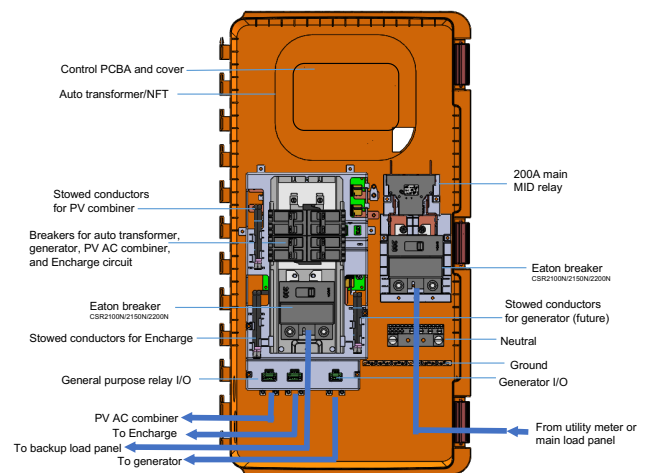
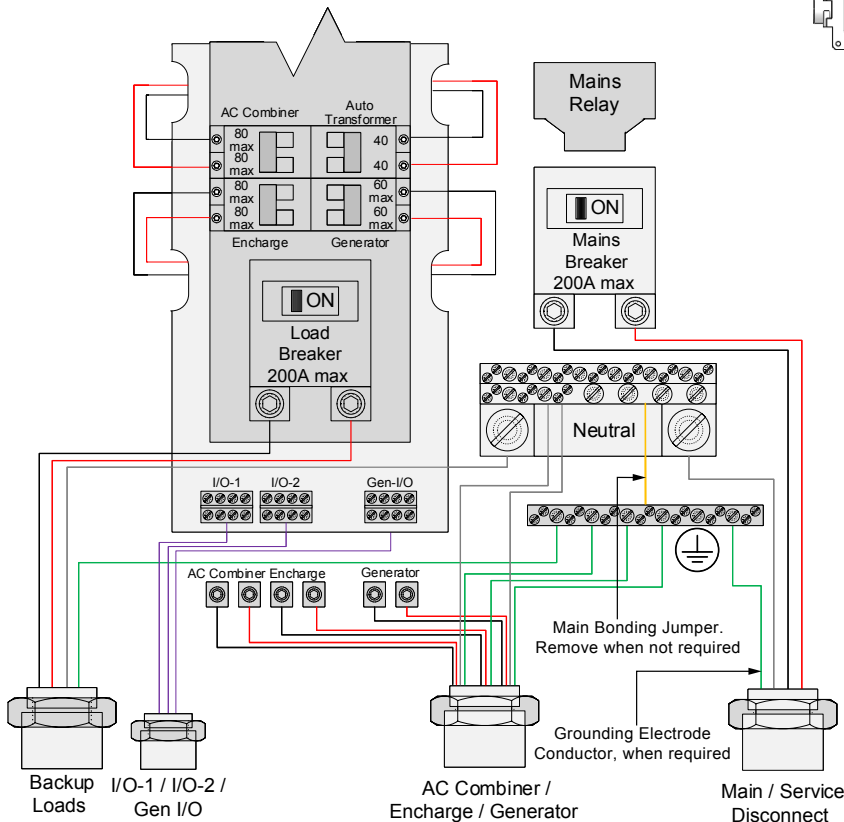

Breaker placement and other connections

AC power wire

6 Close and Energize Enpower

⚠ WARNING: Before energizing, make sure that ALL Enpower connections are properly installed and conductors terminated.

- A) Replace the deadfront. Tighten the cover screws using a Phillips screw driver.

⚠ WARNING! Risk of equipment damage. Ensure that no conductors are pinched before replacing the cover.

⚠ WARNING! Conductors are factory provided for the generator (future), AC Combiner and Encharge. If no generator is used with the system, these conductors will not be terminated. If the Combiner does not connect to the Enpower, these also will not be terminated. When these wires are not terminated, they should remain stowed in the clips on the plastic frame supporting the panel board interior and their end caps should not be removed.

⚠ DANGER: Risk of electric shock. There are many potential sources of voltage. Check any Enphase Encharge battery, PV, or other generation source for voltage.

- B) You must ensure that all electrical circuits external to Enpower are completed and safe before energizing Enpower in the following order:
- NFT breaker
 - Main breaker
 - PV breaker
 - Encharge breaker
 - Generator (future) breaker
 - Load breaker.
- C) Energize the circuit feeding the Enpower. If installed, turn the breaker feeding the Enpower to the on position.
- D) Close and secure the door of the Enpower.

CONFIGURE and ACTIVATE

Use the Enphase Installer Toolkit to commission the Enpower. Once connected to the Envoy, refer to the Installer Toolkit help topics for more information.

After the IQ Envoy has detected the Enpower, the Enpower LEDs operate as described in the following section.

OPERATION

a Overview

- A) If you do not see the Enpower information in Enlighten, check that the IQ Envoy and the Internet connection are working.

SAFETY

IMPORTANT SAFETY INSTRUCTIONS. SAVE THESE INSTRUCTIONS. This guide contains important instructions that you must follow during installation and maintenance of the Enphase Enpower. Failing to follow any of these instructions may void the warranty (enphase.com/warranty).

In Case of Fire or Other Emergency

In all cases:

- If safe to do so, switch off the AC breaker for the Enpower circuit, and if an isolator switch is present, switch off the AC isolator for the Enpower circuit.
- Contact the fire department or other required emergency response team.
- Evacuate the area.

In case of fire:

- When safe, use a fire extinguisher. Suitable types are A, B, and C dry chemical fire extinguishers. Additional extinguishing media include carbon dioxide, or alcohol-resistant foams.



In case of flooding:

- Stay out of water if any part of the Enpower or wiring is submerged.
- If possible, protect the system by finding and stopping the source of the water, and pumping it away.
- If water has contacted the UNIT, call your installer to arrange an inspection. If you are sure that water has never contacted the battery, let the area dry completely before use.

In case of unusual noise, smell or smoke:

- Ensure nothing is in contact with the Enpower or in the venting area on top of the Enpower.
- Ventilate the room.
- Contact Enphase Customer Support at enphase.com/en-us/support/contact.











Safety and Advisory Symbols

	DANGER: This indicates a hazardous situation, which if not avoided, will result in death or serious injury.
	WARNING: This indicates a situation where failure to follow instructions may be a safety hazard or cause equipment malfunction. Use extreme caution and follow instructions carefully.
	NOTE: This indicates information particularly important for optimal system operation. Follow instructions carefully.

Safety Instructions

	DANGER: Risk of electric shock. Risk of fire. Only qualified electricians should install, troubleshoot, or replace the Enpower.
	DANGER: Risk of electric shock. Risk of fire. Do not attempt to repair the Enpower. DO NOT REMOVE THE DEADFRONT – NO SERVICEABLE PARTS. Tampering with or opening the Enpower will void the warranty. If the Enpower fails, contact Enphase Customer Support for assistance at enphase.com/en-us/support/contact .
	DANGER: Risk of electric shock. Do not use Enphase equipment in a manner not specified by the manufacturer. Doing so may cause death or injury to persons, or damage to equipment.
	DANGER: Risk of electric shock. Do not install the Enpower without first removing AC power from the photovoltaic system and ensuring that the DC switch on the Enphase Encharge batteries are off. Disconnect the power coming from the photovoltaics and ensure that the DC switch on the Encharge batteries are off before servicing or installing.
	DANGER: Risk of electric shock. Risk of fire. Do not work alone. Someone should be in the range of your voice or close enough to come to your aid when you work with or near electrical equipment.
	DANGER: Risk of fire. Do not allow or place flammable, sparking, or explosive items near the Enpower.
	DANGER: Risk of electric shock. In areas where flooding is possible, install the Enpower at a height that prevents water ingress.
	WARNING: Risk of equipment damage. Enpower is shipped and stored on its back. The upright position is only needed when installed.
	WARNING: You must install the Enpower only on a suitable wall using an Enphase wall-mount bracket.
	WARNING: Before installing or using the Enpower, read all instructions and cautionary markings in this guide and on the equipment.
	WARNING: Do not install or use the Enpower if it has been damaged in any way.
	WARNING: Do not sit on, step on, place objects on, or insert objects into the Enpower.

Safety Instructions, continued

	WARNING: Do not place beverages or liquid containers on top of the Enpower. Do not expose the Enpower to liquids or flooding.
	NOTE: Perform installation and wiring, including protection against lightning and resulting voltage surge, in accordance with all applicable local electrical codes and standards.
	NOTE: Because Encharge is grid forming, you must install signage in accordance with NEC articles 705, 706, and 710.
	NOTE: Using unapproved attachments or accessories could result in damage or injury.
	NOTE: Install properly rated over current protection as part of the system installation.
	NOTE: To ensure optimal reliability and to meet warranty requirements, the Enpower must be installed and/or stored according to the instructions in this guide.
	NOTE: The Enpower is compatible only with the IQ Envoy communications gateway properly fitted with USB hub, USB radios, and production and consumption CTs . The IQ Envoy is required for operation of the Enpower. Earlier versions of the Enphase Envoy communications gateway are incompatible.
	NOTE: The Enphase Enpower is intended to operate with an Internet connection through the Envoy. Failure to maintain an Internet connection may have an impact on the warranty. See Limited Warranty for full terms and services (enphase.com/warranty).
	NOTE: When replacing an Enphase Enpower, you must replace it with an Enpower of the same type, with the same AC current rating.
	NOTE: Properly mount the Enpower. Ensure that the mounting location is structurally suited to bearing the weight of the Enpower.
	NOTE: During use, storage, and transport, keep the Enpower: <ul style="list-style-type: none"> • Properly ventilated • Away from water, other liquids, heat, sparks, and direct sunlight • Away from excessive dust, corrosive and explosive gases, and oil smoke • Away from direct exposure to gas exhaust, such as from motor vehicles • Away from falling or moving objects, including motor vehicles. If mounted in the path of a motor vehicle, we recommend a 91cm (36-inch) minimum mounting height • In a location compliant with fire safety regulations • In a location compliant with local building codes and standards

Environmental Protection



ELECTRONIC DEVICE: DO NOT THROW AWAY. Waste electrical products should not be disposed of with household waste. Refer to your local codes for disposal requirements.