

# Installation Manual

## 2" Series Top of Pole Mount

[www.mtsolar.us](http://www.mtsolar.us)  
844-MT-SOLAR (687-6527)

2019 V2.2

Thank you for choosing MT Solar Pole Mounts.

It is the installer’s responsibility to determine foundation parameters based on local site conditions, such as wind speed, snow load, soil type, exposure category, etc. Installations also must comply with local building regulations and requirements.

We recommend consulting an engineer for a recommendation on foundation dimensions and pipe size and thickness. MT Solar can also provide a stamped drawing engineered for site-specific requirements for an additional fee. Please contact us to find out more.

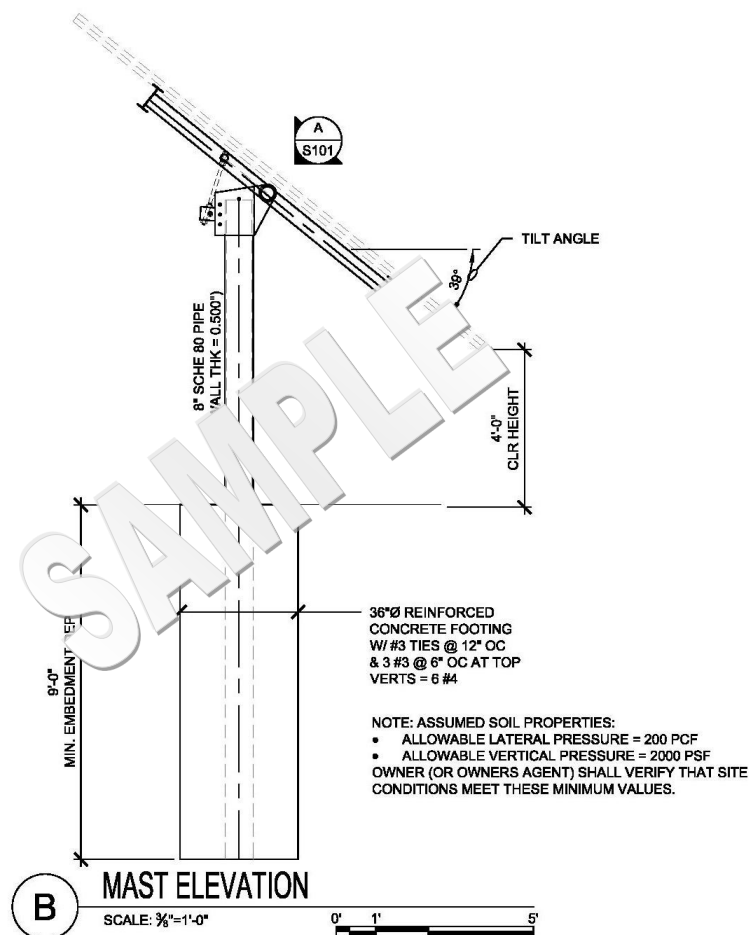

**Tips for Conventional Pipe Installation:**

- Dig hole according to recommended depth and diameter.
- Set pipe in hole and use a level to ensure it is plumb and vertical to the ground.
- If installing multiple poles, use a string to line up pipes.
- Brace pipe to prevent it from moving while pouring concrete.
- Proper compaction of backfill around sonotube or form is recommended, unless pouring so that concrete is in direct contact with the soil.
- Allow concrete to cure for recommended length of time.

# Installation Guide

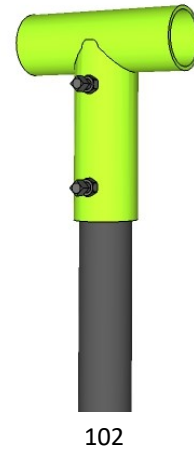
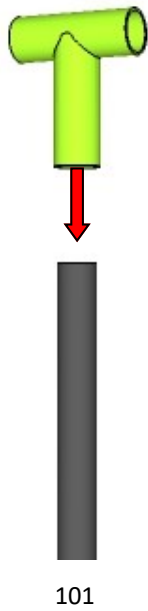

101: With the 2" Sch 40 pipe installed in the ground, slide the pole cap over the pipe.

102: Tighten the set bolts in the back of the pole cap.

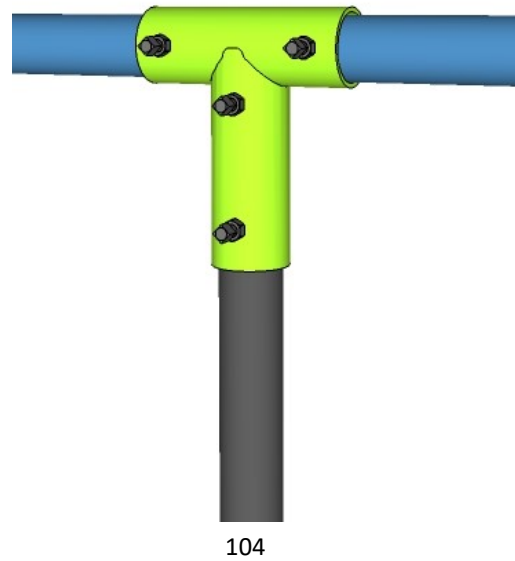
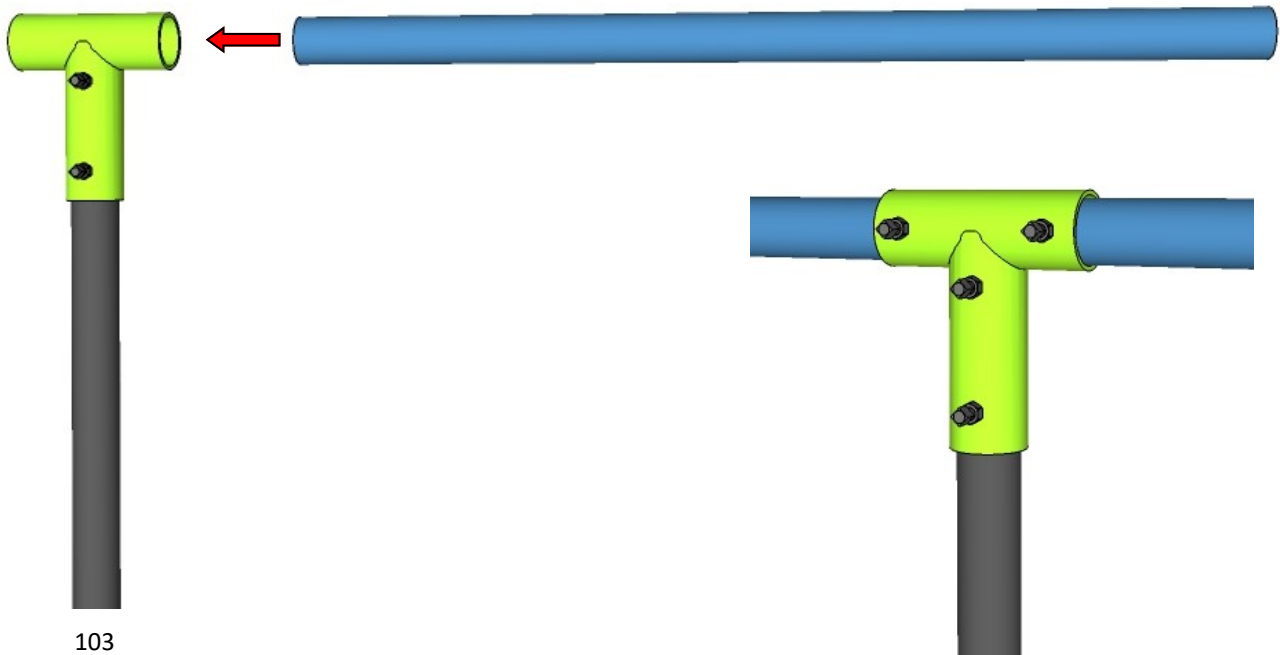

103: Slide the 2" Pipe into the Pole Cap Sleeve.

104: Tighten the set bolts in the Pole Cap.

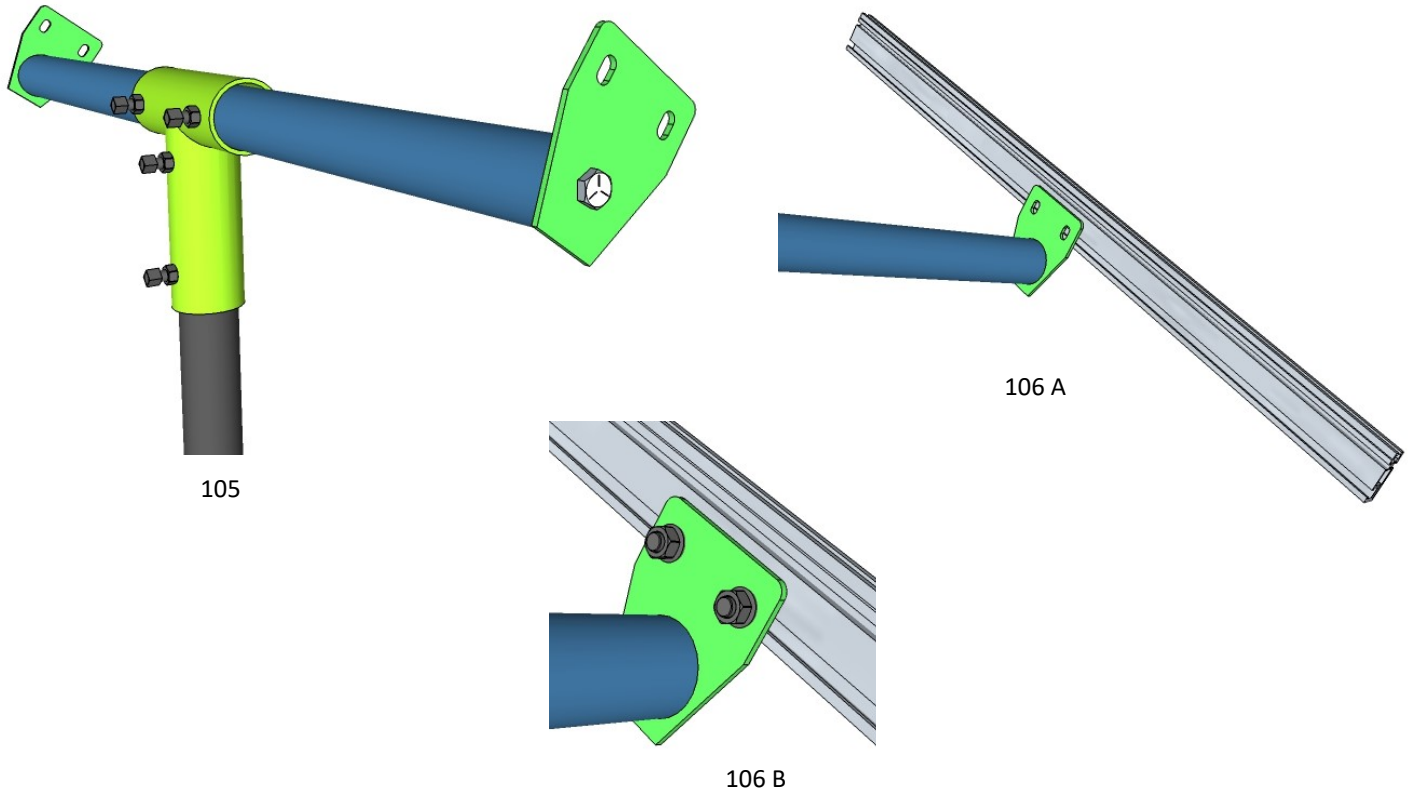

105: Attach the Rail Adapters to the ends of the 2" Pipe and tighten.

106: Line up the bottom slot on the aluminum rail with the holes in the rail adapter. Slide stainless hardware into the slot and tighten.

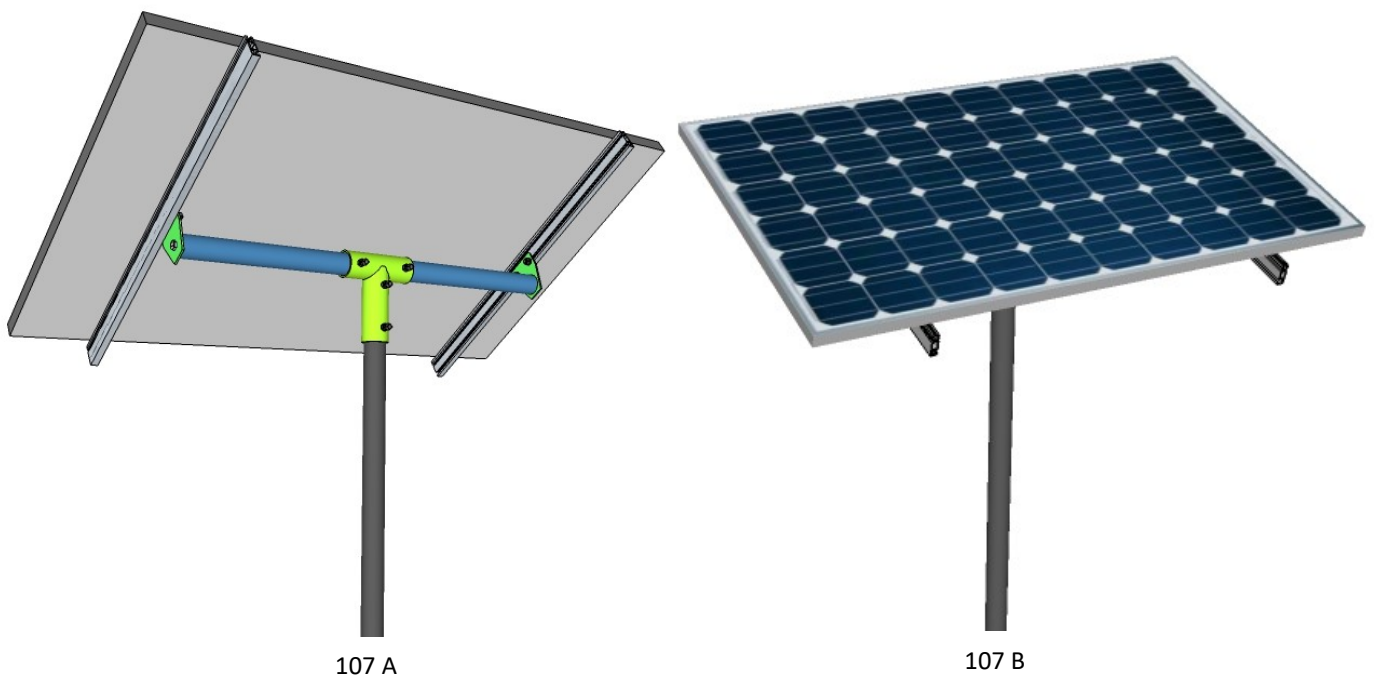

107: Attach aluminum rails to the rail adapter . Install Solar Modules as per Mounting Rail and module manufacturer instructions using top clamps.

844-MT-SOLAR (687-6527)

[sales@mtsolar.us](mailto:sales@mtsolar.us)

[www.mtsolar.us](http://www.mtsolar.us)

54179 Herak Road

Charlo, MT 59824

